

# 100 學年四技二專第二次聯合模擬考試 土木與建築群 專業科目 (一) 詳解

100-2-06-4

1	2	3	4	5	6	7	8	9	10	11	12	13	14	15	16	17	18	19	20
D	A	C	B	C	A	B	D	A	B	C	D	B	D	C	A	A	D	C	B
21	22	23	24	25	26	27	28	29	30	31	32	33	34	35	36	37	38	39	40
D	D	A	B	C	C	B	A	B	C	D	C	A	D	A	B	D	C	A	B

## 第一部份：工程力學

1. (A) 力矩是滑動向量  
(B) 汽缸中的力是接觸力，其接觸物是空氣  
(C) 力的三要素是大小、方向、作用點

2.  $\frac{W}{5} = \frac{4000}{3}$   
 $W = 6666.67$

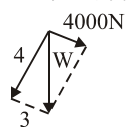

3.  $\frac{800 - N}{800} = \frac{3}{4}$ ,  $N = 200 \text{ N}(\uparrow)$

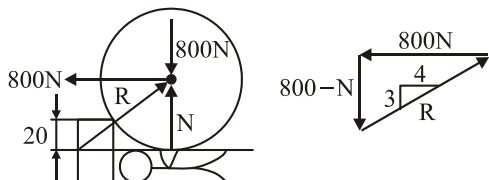

4.  $\Sigma M_A = 40 \times 5 + 120 = 320$ ,  $320 = 40x$ ,  $\therefore x = 8 \text{ m}$

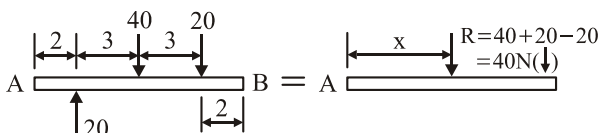

5.  $\Sigma M_x = 0$ ,  $R \times 30 + R \times 5 - R \times y = 0$ ,  $y = 35 \text{ m}$   
 $\Sigma M_y = 0$ ,  $R \times 30 - R \times 40 - R \times x = 0$ ,  $x = -10 \text{ m}$   
 (R = 浮力)

6.  $R_x = 100 + 50\sqrt{2} = 170.7$ ,  $R_y = 100 + 50\sqrt{2} = 170.7$   
 $R = \sqrt{R_x^2 + R_y^2} = 170.7\sqrt{2} = 241 \text{ N}$

$\Sigma M_A = 50\sqrt{2} \times 7 - 100 \times 4 = 95 \text{ N}\cdot\text{m}(\curvearrowleft)$

7.  $\Sigma F_y = 0$

$T + R - 100 = 0$   
 $T = 100 - R$   
 $\Sigma M_A = 0$

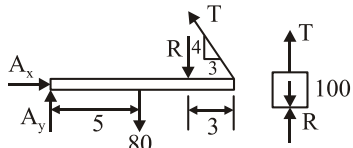

$80 \times 5 + R \times 7 - \frac{4}{5}T \times 10 = 0$

$R = 26.67 \text{ N}$

8.

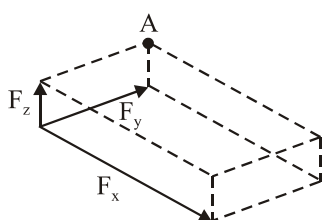

$\vec{F} = F_x + F_y + F_z$   
 $= 390\left(\frac{12\vec{i} + 4\vec{j} + 3\vec{k}}{\sqrt{12^2 + 4^2 + 3^2}}\right) = 360\vec{i} + 120\vec{j} + 90\vec{k}$

(1)  $F_x$  對 A 點產生的力矩為

1.  $M_{z1} = F_x y = 360 \times 4 = 1440$

2.  $M_{y1} = F_x z = -360 \times 3 = -1080$

3.  $M_{x1} = 0$  ( $F_x$  與 x 軸平行)

(2)  $F_y$  對 A 點產生的力矩為

1.  $M_{x2} = F_y z = 120 \times 3 = 360$

2.  $M_{y2} = 0$  ( $F_y$  與 y 軸平行)

3.  $M_{z2} = F_y x = 120 \times 0 = 0$

(3)  $F_z$  對 A 點產生的力矩為

1.  $M_{x3} = F_z y = -90 \times 4 = -360$

2.  $M_{y3} = F_z x = +90 \times 0 = 0$

3.  $M_{z3} = 0$  ( $F_z$  與 z 軸平行)

由上列  $M_x = M_{x1} + M_{x2} + M_{x3} = 0 \vec{i}$

$M_y = M_{y1} + M_{y2} + M_{y3} = -1080 \vec{j}$

$M_z = M_{z1} + M_{z2} + M_{z3} = +1440 \vec{k}$

$\therefore \vec{M}_A = 0 \vec{i} - 1080 \vec{j} + 1440 \vec{k}$

9. 截面法應該在構件之間，不是通過連結點

10.  $\Sigma M_G = 0$ ,  $F_{AB} \times \sin 45^\circ \times 30 - 2000 \times 10 - 2000 \times 20 = 0$   
 $F_{AB} = 2828 \text{ N}(\text{壓力})$

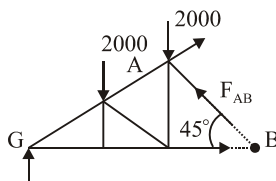

11. 靜止角等於摩擦角

12.  $\Sigma M_A = 0$

$\frac{P}{4} \times r \cos \theta - \frac{W}{4} \times a = 0$

$\therefore \theta$  很小,  $\therefore \cos \theta = 1$

$\frac{P}{4} \times r = \frac{W}{4} \times a$

$P = \frac{Wa}{r} = \frac{2 \times 10^5 \times 0.05}{50} = 200 \text{ N}$

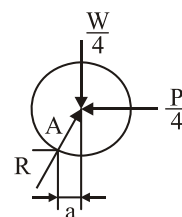

13.  $\bar{x} = \frac{0+12+8}{3} = 6.66$   
 $\bar{y} = \frac{0+8-6}{3} = \frac{2}{3} = 0.66$

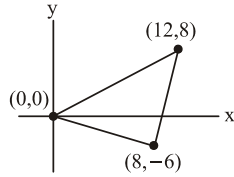

14.  $J = I_x + I_y = I_{x'} + I_{y'}$   
 $7200 = I_{x'} + I_{y'} = 2400 + I_{y'}$   
 $\therefore I_{y'} = 4800 \text{ cm}^4$

15.  $\Sigma F_x = 0$   
 $P \cos 30^\circ - T \sin 30^\circ = 0 \dots\dots ①$   
 $\Sigma F_y = 0$   
 $T \cos 30^\circ - P \sin 30^\circ - 10000 = 0 \dots\dots ②$   
 由①②聯立得  $P = 10000 \text{ N}$   
 $\frac{P}{A} = \frac{\delta}{n} , \frac{10000}{\frac{\pi d^2}{4}} = \frac{216.65}{1.2}$

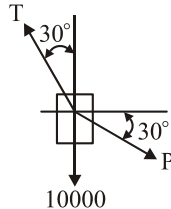

$d = 8.4 \text{ mm}$

16. 水中壓力  $\rho = 1 \text{ g/cm}^3$   
 $h = 100 \text{ m} = 10000 \text{ cm}$   
 $\sigma_x = \sigma_y = \sigma_z = \rho h = -10000 \text{ g/cm}^2$   
 $= -10 \text{ kg/cm}^2 (\text{壓應力})$   
 $E_v = \frac{E}{3(1-2\mu)} = \frac{2.1 \times 10^6}{3(1-2 \times 0.25)} = 1.4 \times 10^6 \text{ kg/cm}^2$   
 $\epsilon_v = \frac{\sigma}{E_v} = \frac{-10}{1.4 \times 10^6} = -7.14 \times 10^{-6} , \epsilon_v = \frac{\Delta V}{V}$   
 $\Delta V = \epsilon_v V = -7.14 \times 10^{-6} \times \frac{4}{3} \pi (10^3)^3 = -0.03 \text{ cm}^3$

17.  $P_R + P_L - 5000 = 0 \dots\dots ①$   
 $\delta_R = \delta_L \dots\dots ②$

由②  $\frac{P_R \times 10}{10 \times E} = \frac{P_L \times 5}{10 \times E}$   
 得  $P_L = 2P_R$  代入①

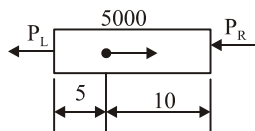

$3P_R = 5000 , P_R = \frac{5000}{3} \text{ kg}$

$\sigma_R = \frac{P_R}{A} = \frac{500}{3} \text{ kg/cm}^2 = 166.67 \text{ kg/cm}^2$

18. (D)  $\mu = \frac{1}{2} - \frac{E}{6E_v}$

19.  $\Sigma F_y = 0 , \omega \times 10 - 3000 = 0 , \omega = 300 \text{ kg/m}$

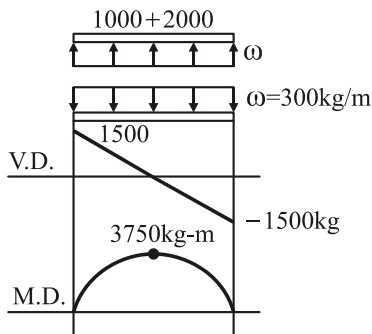

20. (B) 此位置的剪力不一定為零

**第二部份：工程材料**

22. (D) 彈性模數等於應力應變曲線中直線部分之斜率  
 23. (A) 輸氣水泥水密性較佳  
 24. (B) 水泥和標準砂以 1 : 2.75 之重量比  
 25. 粗粒料的面乾內飽和比重 =  $\frac{1550}{1550-950} = 2.58$   
 26. (C) #50 篩是將 1 英吋的間距等分成 50 個小孔  
 27. (B) 表面水量的變化對石子之單位體積重影響較小，對砂的影響較大  
 28. (A) 混凝土 7 天齡期之抗壓強度，約為 28 天齡期之抗壓強度的  $\frac{2}{3}$   
 30. (C) 大理石容易風化，幾乎不使用於室外  
 31. (D) 中國傳統式建築與現今廟宇建築常使用筒板瓦  
 32.  $\frac{400 \times 200}{(10+1) \times (6+1)} = 1039$   
 33. (A) 水玻璃屬於簡單玻璃  
 34. (D) 硬玻璃含有多量之鉀與鈣  
 35. (A) 柔性路面之膠結材料  
 36. (B) 若所須之時間越短，則瀝青材料的黏度越小  
 37. (D) 焦油之感溫性較大  
 38. (C) 針葉樹材較闊葉樹材之劈裂強度小  
 39. (A) 木材利用上，以氣乾比重最為重要  
 40. (B) 強度甚差